

DC CIRCUIT BREAKERS

Type **UR10, UR15**

RAIL VEHICLES

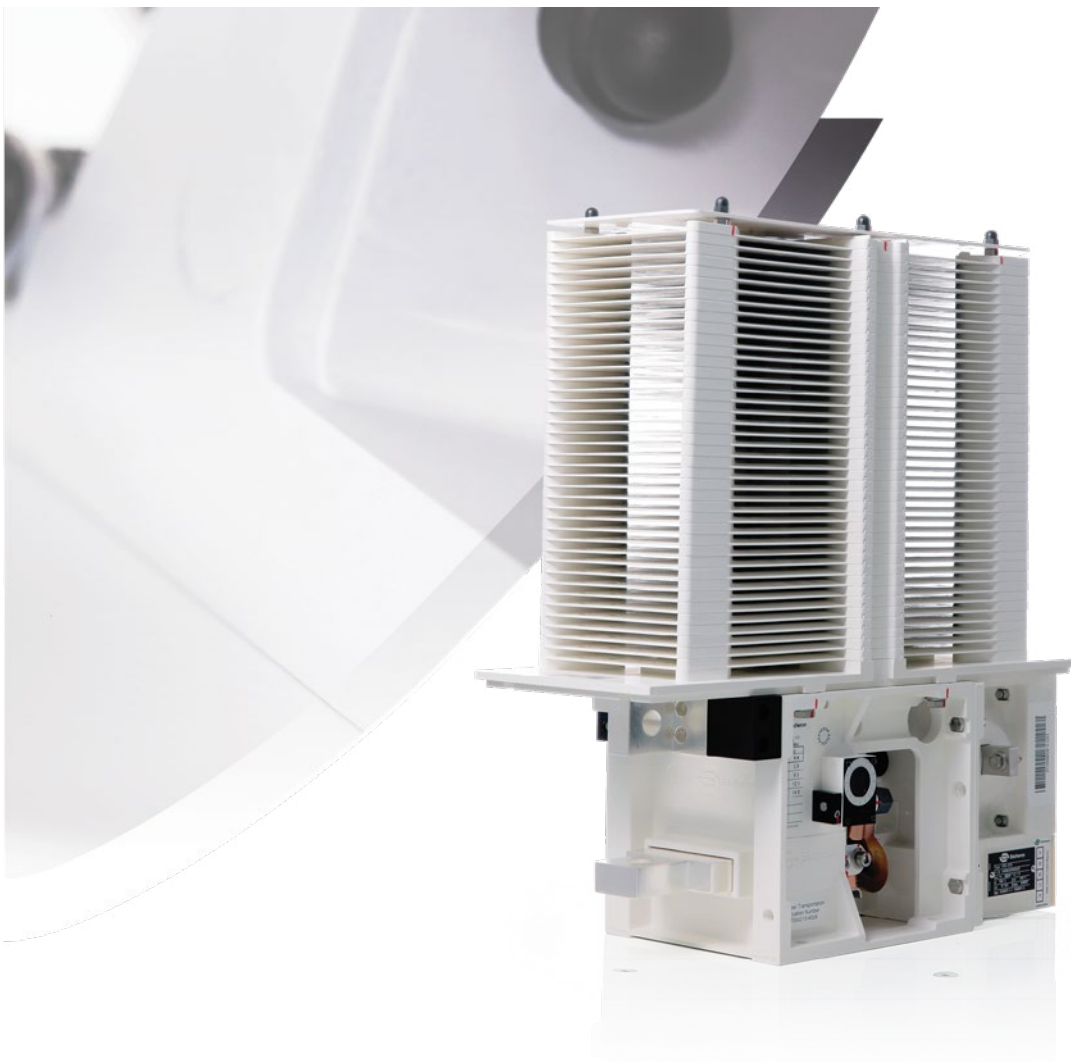

GENERAL INFORMATION

UR10 and **UR15** are DC high-speed current limiting circuit-breakers with natural cooling, trip free, single pole, bi-directional, with electromagnetic blow-out, electric control circuits and direct over-current instantaneous release.

Of open type construction, the UR10 and UR15 can also be delivered with protective enclosure for roof or under-frame mounting on traction vehicles.

These circuit-breakers are primarily designed to protect main and auxiliary circuits of DC traction vehicles against short-circuits and overload currents, as well as to connect or isolate these circuits to and from the vehicles power supply.

Selecting the right product for your vehicles requires careful consideration and computing from Sécheron, for the application load cycle, the environmental temperature and high-voltage cable or busbar section.

APPLICATIONS

- Metro vehicles

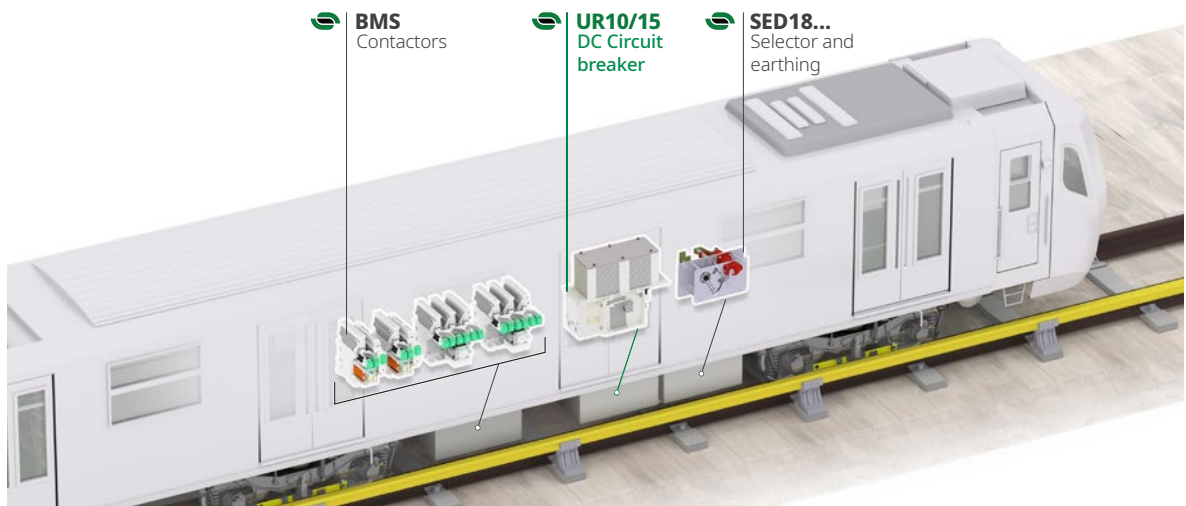

- Tramway and LRV vehicles

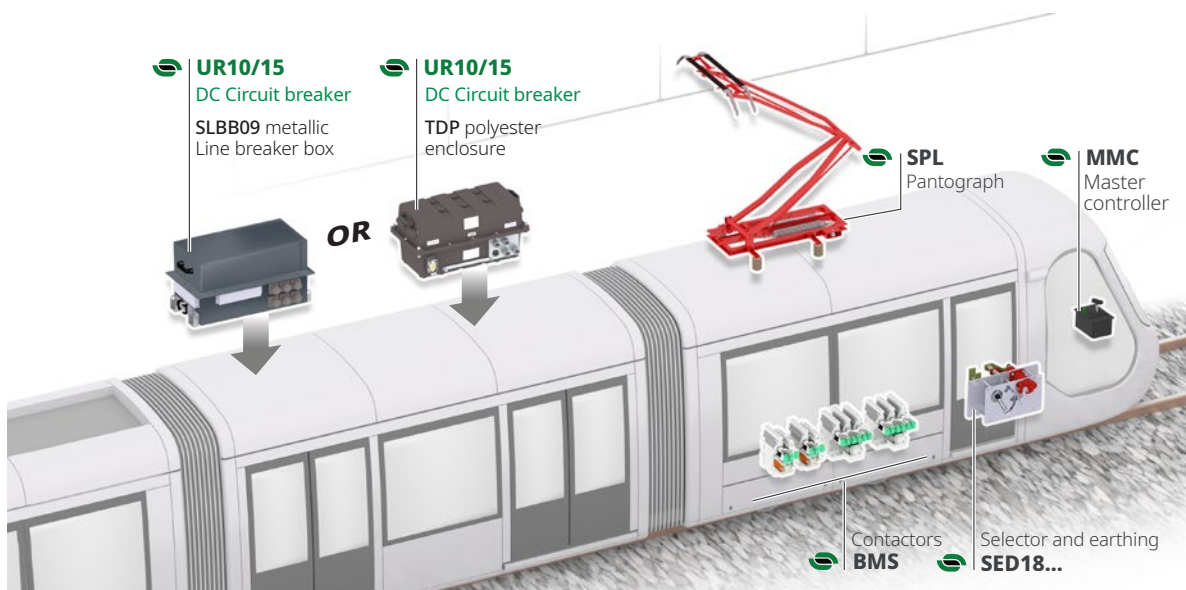

- EMU vehicles

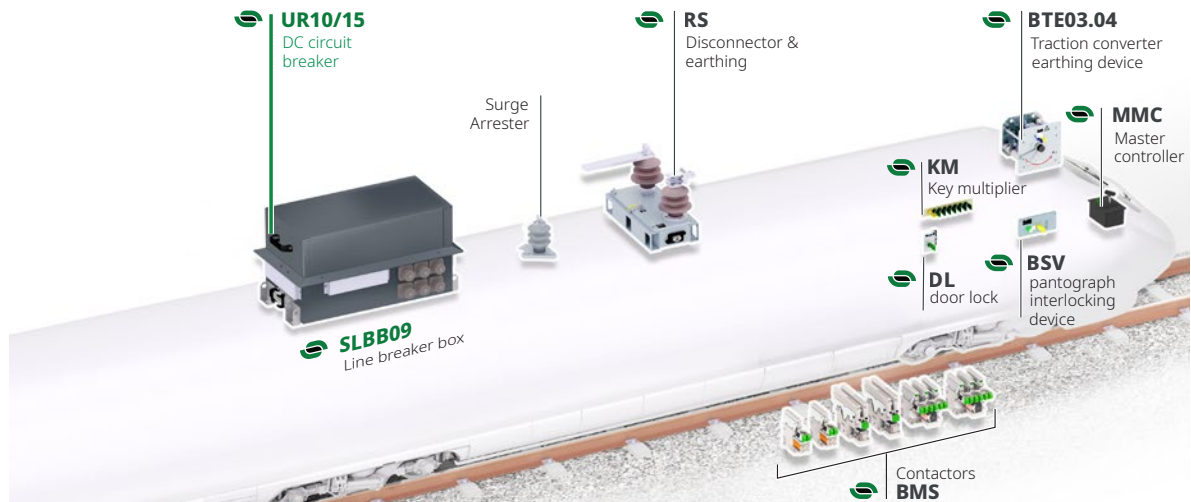

MAIN FEATURES

- Conventional thermal current 1,000 A or 1,500 A
- Rated operational voltage 900 V_{DC} or 1,800 V_{DC}

MAIN BENEFITS

- ✓ Safe with a high insulation level category OV4.
- ✓ High mechanical and electrical endurance: operational frequency C3.
- ✓ Limited maximum arc voltage.
- ✓ Electro-magnetic closing and reduced holding power.
- ✓ Optional integrated ECO-Drive control module.
- ✓ Optional protective enclosure for roof and underframe mounting.
- ✓ Optional -50 °C version.
- ✓ Cadmium free.
- ✓ Very low maintenance requirements.
- ✓ Proven design with worldwide experience and acceptance.
- ✓ Compact and lightweight.
- ✓ Insulation material according to EN 45545-2.
- ✓ Reference standards IEC/EN 60077-3 and IEC/EN 61373.

BREAKING CURRENT PARAMETERS

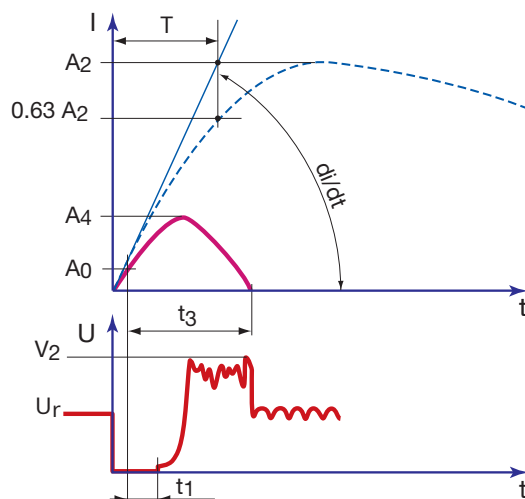

- A_2 = Peak of Short-circuit
- A_0 = Setting of maximum current release
- A_4 = Cut off current
- di/dt = Initial current rate of rise
- T = Circuit time constant
- U_r = Rated operational voltage
- V_2 = Peak of the arc voltage
- t_1 = Mechanical opening time
- t_3 = Total break time

Opening time

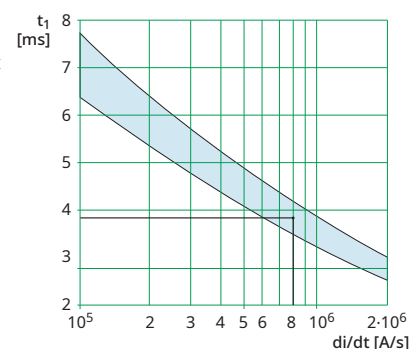

Relationship between opening time t_1 and the initial rate of rise of current di/dt for direct over-current instantaneous release.

Example for di/dt of $8 \cdot 10^5$ A/s: the opening time is about 3.9 ms.

DATA FOR PRODUCT SELECTION

| | Symbol | Unit | UR10 | UR15 |
|--|-------------|---------------------|----------------------|-----------|
| MAIN HIGH VOLTAGE CIRCUIT | | | | |
| Rated voltage | | | | |
| - Arc chute type 41 | U_r | [V _{DC}] | 900 | 900 |
| - Arc chute type 42 | U_r | [V _{DC}] | 1,800 | 1,800 |
| Maximum operational voltage | | | | |
| - Arc chute type 41 | | [V _{DC}] | 1,000 | 1,000 |
| - Arc chute type 42 | | [V _{DC}] | 2,000 | 2,000 |
| Rated insulation voltage | U_{Nm} | [V _{DC}] | 2,300 | 2,300 |
| Rated operational current | I_r | [A] | 1,000 | 1,500 |
| Conventional free air thermal current ⁽¹⁾ | I_{th} | [A] | 1,000 | 1,500 |
| Overload capacity ⁽²⁾ | | | | |
| - 10s | | [A] | 3,200 ⁽³⁾ | 3,600 |
| - 1 min | | [A] | 2,200 | 3,600 |
| - 5 min | | [A] | 1,700 | 2,680 |
| - 1 hour | | [A] | 1,150 | 1,750 |
| Operational category | | | C3 | |
| Over-voltage category | | | OV4 | |
| Rated short-circuit making and breaking capacity / Time constant | | | | |
| - Arc chute type 41 | $A_2 / T1$ | [kA]/[ms] | - | 17/0 |
| | $A_2 / T2$ | [kA]/[ms] | 30/15 | 30/15 |
| | $A_2 / T3$ | [kA]/[ms] | 30/50 | 30/50 |
| | $A_2 / T4$ | [kA]/[ms] | 30/150 | 30/150 |
| - Arc chute type 42 | $A_2 / T1$ | [kA]/[ms] | - | 17/0 |
| | $A_2 / T2$ | [kA]/[ms] | 30/15 | 30/15 |
| | $A_2 / T3$ | [kA]/[ms] | 30/40 | 30/40 |
| | $A_2 / T4$ | [kA]/[ms] | 30/100 | 30/100 |
| Direct over-current instantaneous release ⁽⁴⁾ | | [kA] | 0.45 - 3.2 | 0.9 - 3.6 |
| Power frequency withstand voltage | | | | |
| - Between opened main contact | U_a | [kV] | 8 | 8 |
| - Between closed main contact and earth & control circuit | U_a | [kV] | 10 | 10 |
| - Between low voltage circuits and earth | U_a | [kV] | 2 | 2 |
| Rated impulse withstand voltage | U_{Ni} | [kV _{DC}] | 18 | 18 |
| Maximum peak arc voltage | | | | |
| - Arc chute 900 V _{DC} | \hat{U}_c | [kV _{DC}] | 1.1 - 3.0 | 1.1 - 3.0 |
| - Arc chute 1,800 V _{DC} | \hat{U}_c | [kV _{DC}] | 2.1 - 6.1 | 2.1 - 6.1 |

⁽¹⁾ At Tamb = +40°C and tested with a size of high voltage connection per terminal: 2 x 240 mm² for UR10 and 3 x 300 mm² for UR15. • ⁽²⁾ Non cumulative overloads at Tamb=+40°C, starting from breaker's cold state, and with high voltage connection size as per ⁽¹⁾. • ⁽³⁾ The values are based on trip setting range, 1.5 - 3.2 kA for UR10 and 1.8 - 3.6 kA for UR15. May the selected trip setting range be different, maximum values of the overload capacity should match the maximum value of the selected tripping range. • ⁽⁴⁾ For range selection, refer to the table 4.

LOW VOLTAGE AUXILIARY CIRCUIT

Control circuit

| | | | |
|---|----------|--------------------|---|
| Nominal supply voltage | U_n | [V _{DC}] | 24, 32, 36, 48, 72, 87, 96, 110, 220 |
| Range of voltage | | | [0.7 - 1.25] Un |
| Nominal closing power ⁽⁵⁾ | P_c | [W]/[s] | 835/1 |
| Nominal holding power for electric holding ⁽⁵⁾ | P_h | [W] | 2.5 |
| Nominal opening power for electric holding ⁽⁵⁾ | | [W] | 0 |
| Nominal holding power for magnetic holding ⁽⁵⁾ | P_h | [W] | 0 |
| Nominal opening power for magnetic holding ⁽⁵⁾ | P_{dm} | [W]/[s] | 35/1 |
| Mechanical opening time on opening order ⁽⁶⁾ | | [ms] | 5-10 (electric holding), 10-20 (magnetic holding) |
| Mechanical closing time on closing order ⁽⁶⁾ | t_c | [ms] | ~ 70 |

Auxiliary contacts

| | | | |
|--|----------|--------------------|--|
| Type of contacts | | | Potential free (PF) |
| Number of auxiliary contacts | | | 2a + 2b or 6a + 6b |
| Rated voltage | | [V _{DC}] | 24 to 110 |
| Conventional thermal current | I_{th} | [A] | 10 |
| Switching categories according to EN60947 (silver contacts) | | | - AC-15 230 VAC 1.0 A - DC-13 110 VDC 0.5 A |
| Minimum let-through current at 24 V _{DC} ⁽⁷⁾ | | [mA] | ≥ 10 (silver contacts) or 4 ≤ I < 10 (gold contacts) |

Low voltage interface

| | | | |
|--------------------------------|--|--|---------------------------|
| Type of connection | | | |
| - Without protective enclosure | | | Direct (screw connection) |
| - With protective enclosure | | | Connector type Harting |

⁽⁵⁾ At Un and Tamb = +20°C. • ⁽⁶⁾ At Un and Tamb = +20°C. • ⁽⁷⁾ For a dry and clean environment.

OPERATING CONDITIONS

| | | | |
|--|-----------|--------------|----------------------------------|
| Installation | | | Indoor or outdoor ⁽⁸⁾ |
| Vibrations and shocks (according to IEC/EN61373) | | | Category 1, class B |
| Altitude | | [m] | ≤ 2,000 |
| Working ambient temperature | T_{amb} | [°C] | - 25 to + 70 ⁽⁹⁾ |
| Relative Humidity | | | 95% at + 40°C |
| Pollution degree | | | PD3 |
| Minimum mechanical durability | N | [Operations] | 5 x 100,000 |

⁽⁸⁾ Outdoor with optional enclosure (refer to page 9 and 10). • ⁽⁹⁾ For ambient temperature <-25°C, please contact Sécheron.

REQUIRED INFORMATIONS FOR BREAKER SELECTION

In order to select the appropriate breaker suited to your application, the following informations must be provided to Sécheron. Once these data computed, and in function of the maximum allowed temperature rise of the critical parts of the different breakers

UR10/15, Sécheron will recommend the breaker type that matches your application. The following data and informations must be sent to Sécheron for computing.

1- APPLICATION LOAD CYCLE

An excel table with the load cycles the breaker will have to withstand in the application, shall be sent to Sécheron for computing, and shall include as a minimum the following information:

- The peak value I_{p3} and the $i^2 \times t$ of the most energetical load of the vehicle's trip
- The highest peak value I_{p1} of the vehicle's trip and its duration
- The I_{rms} current (Root Means Square) of the vehicle's trip

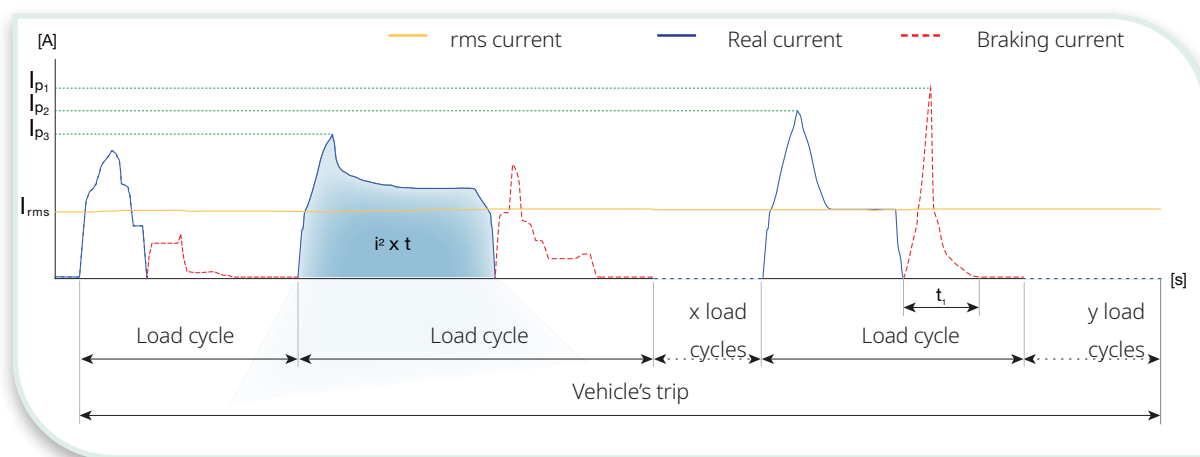

2 - MAXIMUM WORKING AMBIENT TEMPERATURE OF THE CIRCUIT-BREAKER IN THE APPLICATION °C

3 - HIGH VOLTAGE CONNECTION TYPE AND NUMBER OF CONNECTION PER HIGH VOLTAGE TERMINAL

- Cable: :1 :2 :3
 - Busbar: :1 :2 :3

4 - INDIVIDUAL HIGH VOLTAGE CONNECTION SIZE

- Cable: mm²
 - Busbar: mm x mm

Note: It is recommended that the current density of the high voltage connections wired to the DC circuit-breaker and related to the rms current of the application shall not exceed 1.7 ~ 2.0 A/mm². For current density that exceeds the recommended value, the breaker thermal current may have to be derated in function of the application. time is about 3.9 ms.

DIRECT OVER-CURRENT INSTANTANEOUS RELEASE

| UR10 | UR15 | Designation code | |
|------------|-----------|------------------|---------|
| | | Standard | Options |
| 0.45 - 0.9 | - | | F |
| 0.6 - 1.2 | - | A | |
| 0.9 - 1.8 | 0.9 - 1.8 | B | |
| 1.2 - 2.4 | 1.2 - 2.4 | C | |
| 1.5 - 3.2 | - | D | |
| - | 1.8 - 3.6 | E | |

Available setting ranges (in kA) with their corresponding designation code for selection page 16.

PRODUCT INTEGRATION

MAIN DIMENSIONS

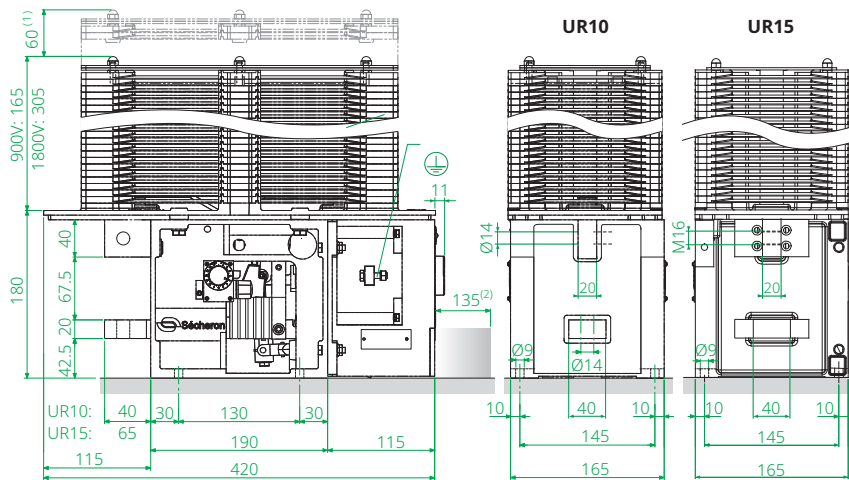

Dimensions without tolerances are indicative. All dimensions are in mm. The maximum allowed flatness deviation of the support frame is 0.5 mm.

⁽¹⁾ Space needed for the removal of the arc chute.

⁽²⁾ Space needed for the removal of the auxiliary housing.

INSULATION DISTANCES

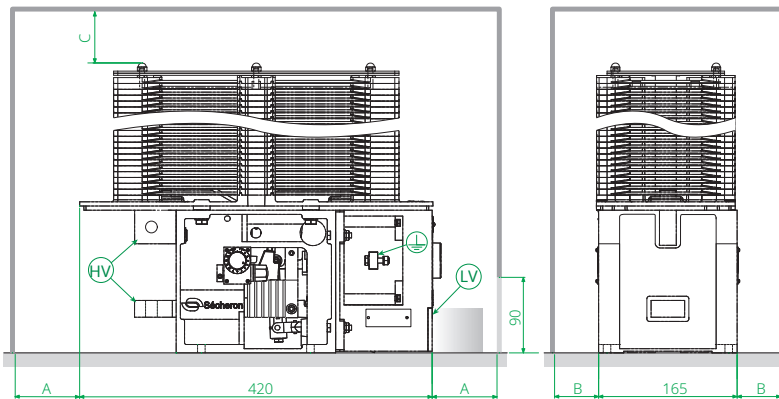

| | | Minimum insulation distances [mm] | |
|--------------------|---|-----------------------------------|------|
| | | UR10 | UR15 |
| To insulating wall | A | 90 | 90 |
| | B | 55 | 55 |
| | C | 0 | 0 |
| To earth | A | 350 | 350 |
| | B | 200 | 200 |
| | C | 150 | 150 |

⁽¹⁾ Space needed for the removal of the arc chute.

⁽²⁾ Space needed for the removal of the auxiliary housing.

WEIGHTS

| | Weights ⁽¹⁾ [kg] | |
|------------------|-----------------------------|------|
| | UR10 | UR15 |
| Arc chute 900 V | 28 | 29 |
| Arc chute 1800 V | 38 | 39 |

⁽¹⁾ Weights for standard circuit-breaker without any option.

LOW VOLTAGE CONTROL DIAGRAM

The **UR** range is equipped with a solenoid coil to perform the usual closing and opening operations.

Two different types of closing devices are available: with electric holding (E-type) or with magnetic holding (M-type).

ELECTRIC HOLDING E-TYPE

- The circuit breaker remains closed with a **reduced "holding" current**. To open the circuit breaker the holding current is cut-off.
- With **E-type** closing device, the circuit breaker cannot remain closed if the low voltage supply is lost.

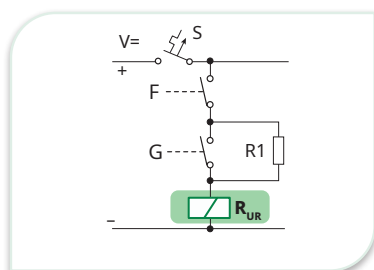

F, G : control contacts
R1 : holding resistor
S : automatic circuit breaker

□ Customer scope
■ Sécheron scope

MAGNETIC HOLDING M-TYPE

- The circuit breaker remains closed **without any control current**. To open the circuit breaker it is necessary to reverse the polarity of the current flowing through the closing coil.
- With the **M-type** closing device, the circuit breaker remains closed when the low voltage supply is lost. It requires the control voltage to be present to open.

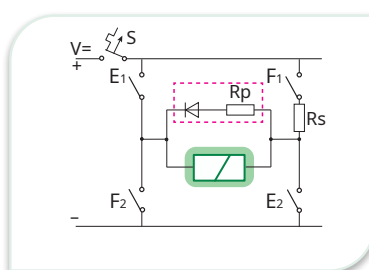

E, F : control contacts
Rs : serial resistor
Rp : parallel resistor
S : automatic circuit breaker

□ Customer scope
■ Sécheron scope

Note:

- For technical data related to closing devices and needed to design the circuit breaker's control circuit, refer to the instruction manual of the selected product.

- For M-type closing device, the circuit breaker's direct tripping function remains always active even if the low voltage supply is lost.

- The duration of the closing pulse (E-type & M-type) as well as the opening pulse (M-type) should be 0.5 - 1 s.

TYPICAL VALUE FOR CLOSING COILS - UR10/15

| | Coil characteristics | | | | | | | | | | | | | |
|--------------------|----------------------------|-------------|-------------|-----------|----------------|-----------|-----------|-----------|-----------------------------------|-------|-----------|-----------|-----------|--|
| | Closing pulse 0.5 to 1s | | | | holding E-type | | | | opening pulse M-type 0,5 to 1s | | | | | |
| U_n | I_{nom} | $I_{min E}$ | $I_{min M}$ | I_{max} | R1 | I_{nom} | I_{min} | I_{max} | Rs | Rp | I_{nom} | I_{min} | I_{max} | |
| [V _{DC}] | [A] | [A] | [A] | [A] | [Ω] | [A] | [A] | [A] | [Ω] | [Ω] | [A] | [A] | [A] | |
| 24 | 34.5 | 18.7 | 20.7 | 58.6 | 12.3 | 1.85 | 1.27 | 2.34 | 1.29 | 0.66 | 7.18 | 4.25 | 10.71 | |
| 36 | 24.2 | 13.0 | 14.5 | 41.0 | 26.6 | 1.28 | 0.88 | 1.62 | 3.00 | 1.50 | 4.82 | 2.87 | 7.15 | |
| 48 | 19.4 | 10.5 | 11.6 | 32.9 | 45.9 | 0.99 | 0.68 | 1.26 | 5.15 | 2.45 | 3.74 | 2.22 | 5.55 | |
| 72 | 12.1 | 6.5 | 7.2 | 20.5 | 106.5 | 0.64 | 0.44 | 0.81 | 12.00 | 6.00 | 2.41 | 1.43 | 3.57 | |
| 110 | 7.6 | 4.1 | 4.6 | 12.9 | 253.0 | 0.41 | 0.28 | 0.52 | 28.50 | 14.60 | 1.55 | 0.92 | 2.30 | |
| 220 ⁽¹⁾ | 3.8 | 2.0 | 2.3 | 6.4 | 1014 | 0.21 | 0.14 | 0.26 | 114 | 59.00 | 0.77 | 0.46 | 1.15 | |

⁽¹⁾ full wave rectified voltage.

LOW VOLTAGE INTERFACE

WITHOUT PROTECTIVE ENCLOSURE

Configuration with 2 or 6 auxiliary switches



Direct connection on auxiliary switches and closing coil. Low voltage cables go through PG11 glands of the auxiliary contacts housing.

WITH PROTECTIVE ENCLOSURE

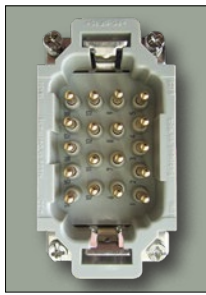

Harting type HAN® M18
(2a + 2b auxiliary switches)



Harting type HAN® M28
(6a + 6b auxiliary switches)

Note: Low voltage connectors are delivered with all pins mounted.

LOW VOLTAGE CONTROL DIAGRAMS

DIRECT CONNECTION (CONFIGURATION WITHOUT PROTECTIVE ENCLOSURE)

AUXILIARY CONTACTS -
2a + 2b CONFIGURATION

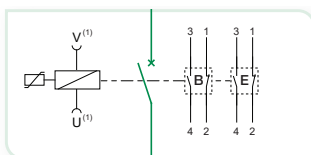

AUXILIARY CONTACTS -
6a + 6b CONFIGURATION

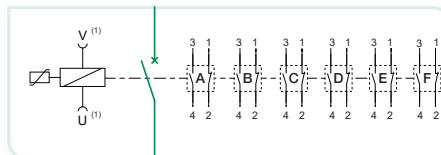

Legend

| | |
|--|--|
| | Circuit breaker main contact |
| | Circuit breaker closing coil |
| | Varistor on coil |
| | Low voltage connector interface (male pin) |
| | 1a+1b - Switch PF |

LOW VOLTAGE CONNECTOR (CONFIGURATION WITH PROTECTIVE ENCLOSURE)

AUXILIARY CONTACTS - 2a + 2b
CONFIGURATION
HARTING TYPE HAN® M18

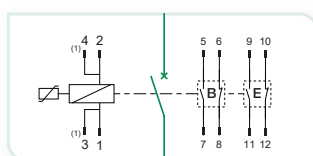

AUXILIARY CONTACTS - 6a + 6b
CONFIGURATION
HARTING TYPE HAN® M28

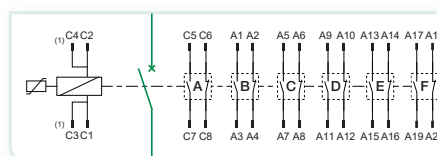

Only the pins related to your selected configuration page 16 will be wired according to the shown pin assignment. The connector will be delivered with all pins mounted even if not all wired.

⁽¹⁾ Double cable only for 24V_{DC} control voltage.

OPTIONS

(SUBJECT TO ADDITIONAL COSTS)

ECO-DRIVE INTEGRATED CONTROL MODULE

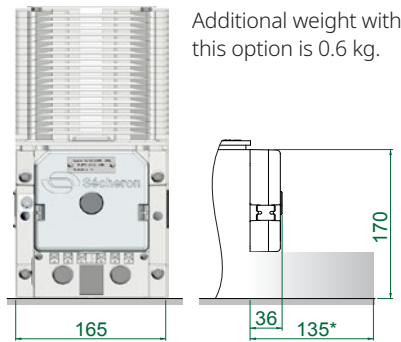

Additional weight with this option is 0.6 kg.

The ECO-Drive is a small control module directly integrated on the UR10 and UR15 breaker, for both stand-alone version or when delivered with protective enclosure, for configuration with electric holding and 2 auxiliary switches. The ECO-Drive is installed on the UR breaker's closing device and manages the closing - holding sequences once it receives a closing order from the vehicle.

* Space needed for the removal of the auxiliary housing

MAIN BENEFITS

- ✓ No more needs of additional hardware to manage the closing - holding sequence.
- ✓ Reduction of the overall space necessary to operate the circuit-breaker.
- ✓ Reduction of overall installation costs of the DC circuit-breaker.
- ✓ Reduction of holding power consumption and operational costs versus conventional holding variant.
- ✓ Reduction of the risks of damaging the closing coil during commissioning and service operations.

LOW VOLTAGE WIRING DIAGRAMS

DIRECT CONNECTION (CONFIGURATION WITHOUT PROTECTIVE ENCLOSURE)

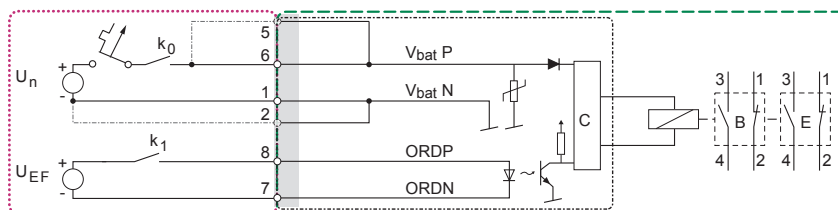

HARTING TYPE HAN® M CONNECTOR (CONFIGURATION WITH PROTECTIVE ENCLOSURE)

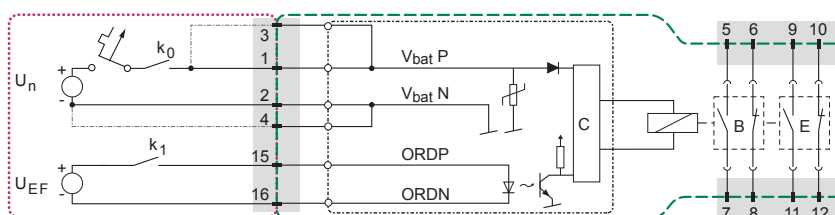

TECHNICAL DATA

| Control circuit | | | |
|--|----------|--------------------|---------------------------------|
| Nominal supply voltage | U_N | [V _{DC}] | 24, 32, 36, 48, 72, 87, 96, 110 |
| Nominal control voltage | U_{EF} | [V _{DC}] | [24 - 110] |
| Range of voltage | | | [0.7 - 1.25] U_n |
| Idle (standby) power | | [W] | < 1.6 |
| Nominal closing power ⁽¹⁾ | P_c | [W]/[s] | 835/1 |
| Nominal holding power ⁽¹⁾ | | [W] | < 8 |
| Nominal opening power ⁽¹⁾ | | [W] | < 1.6 |
| | | | (Idle power - see above) |
| Mechanical opening time on opening order ⁽²⁾ | | [ms] | 5-10 |
| Mechanical closing time on closing order ⁽¹⁾⁽²⁾ | T_c | [ms] | ~70 |

The UR breaker together with the ECO-Drive is fully compliant for electromagnetic compatibility with EN 50121-3-2 and with EN 50155: § 5.1.1.2 short (10 ms) interruptions class S2 and § 5.1.3: voltage dips / variation (at 0.6 U_n during 100ms) class C1.

⁽¹⁾ At U_n and $T_{amb} = +20^\circ\text{C}$

⁽²⁾ Starting when the signal is received by the coil

PROTECTIVE ENCLOSURES

UR10-41/UR15-41TDS/TDP (IP55)

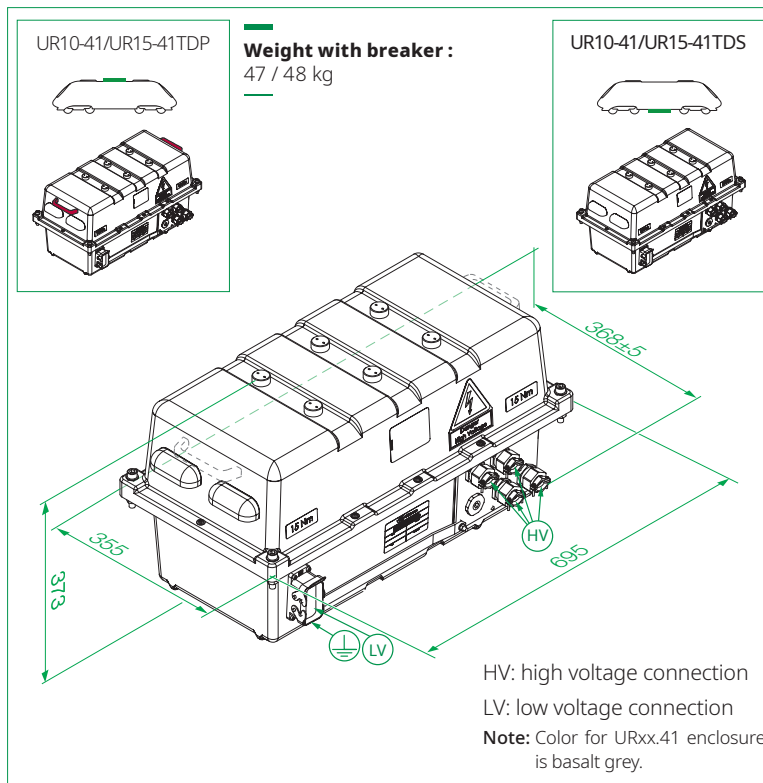

The TDP/TDS enclosures for UR10 or UR15 can be mounted on the vehicle's roof or under the vehicle's frame.

Example of TDP box fixing on the vehicle's roof

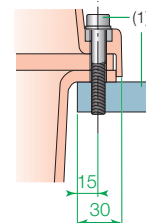

⁽¹⁾ Supporting frame and fixing screws are not delivered with the enclosure.

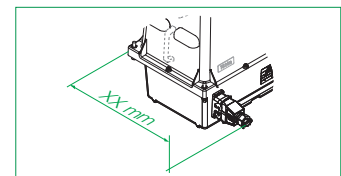

XX: dimension with mobile connector. For values refer to page 12 (based on the type of connector selected)

UR10-42/UR15-42TDS/TDP (IP55)

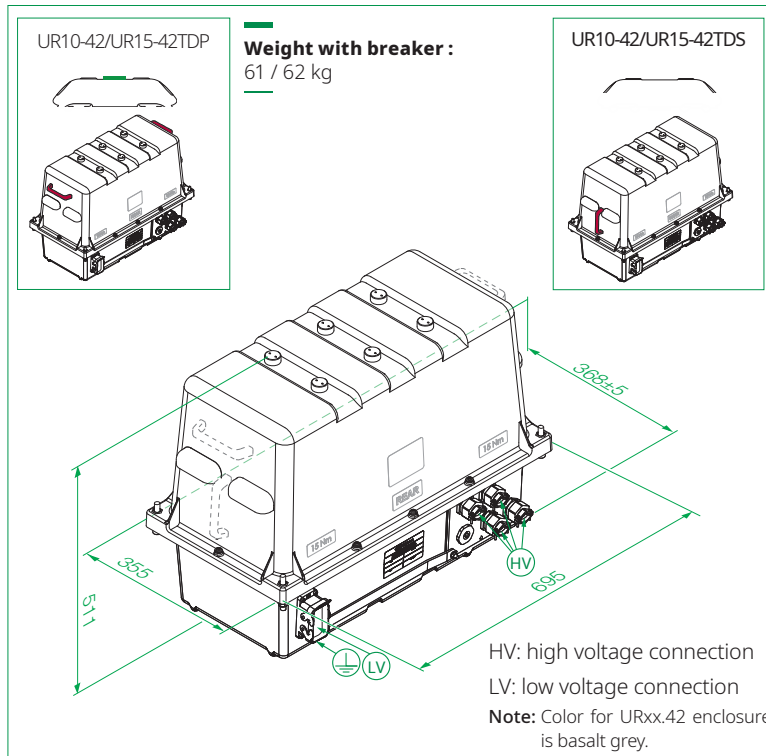

The TDP/TDS enclosures for UR10 or UR15 can be mounted on the vehicle's roof or under the vehicle's frame.

Example of TDP box fixing on the vehicle's roof

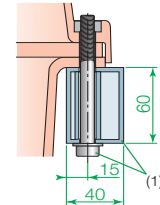

(1) Supporting frame and fixing screws are not delivered with the enclosure.

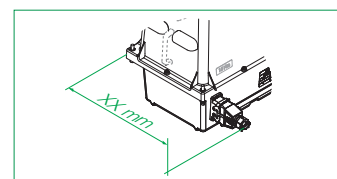

XX: dimension with mobile connector. For values refer to page 12 (based on the type of connector selected)

CABLE GLANDS TYPE SELECTION

| High voltage cable diameter [mm] and cable glands | | | |
|---|--------------------------|--------------------------|------------------|
| | UR10 | UR15 | Designation code |
| | | | Options |
| Metric | 5 - 14.0 mm (M25x1.5) | - | A |
| | 14.1 - 17.0 mm (M25x1.5) | - | B |
| | 17.1 - 19.0 mm (M32x1.5) | - | C |
| | 19.1 - 24.0 mm (M32x1.5) | - | D |
| | 24.1 - 26.0 mm (M40x1.5) | - | E |
| | 26.1 - 33.0 mm (M40x1.5) | - | F |
| | - | 27.0 - 32.0 mm (M50x1.5) | G |
| | - | 32.1 - 34.0 mm (M50x1.5) | H |
| | - | 34.1 - 36.0 mm (M50x1.5) | I |
| | - | 36.1 - 40.0 mm (M50x1.5) | J |
| Type PG | 12.5 - 14.0 mm (PG21) | - | K |
| | 14.1 - 17.0 mm (PG21) | - | L |
| | 17.1 - 19.0 mm (PG21) | - | M |
| | 19.1 - 24.0 mm (PG29) | - | N |
| | 24.1 - 26.0 mm (PG29) | - | P |
| | 26.1 - 33.0 mm (PG36) | - | Q |
| | - | 27.0 - 35.0 mm (PG36) | R |

CABLE GLANDS STANDARD CONFIGURATION





| | 2 cables | 3 cables | 4 cables | 5 cables | 6 cables |
|--|----------|----------|----------|----------|----------|
| Designation code (line 18, page 16) | Code : 2 | Code : 3 | Code : 4 | Code : 5 | Code : 6 |
| Position of cable glands (line 19, page 16) | | | | | |

The high voltage cable gland plate will be delivered assembled according to the selected diagram. The customer can easily change the position of these glands and protection caps according to its own needs.

UR10

UR15

DESIGNATION CODE FOR SEPARATELY ORDERED MOBILE CONNECTOR
(FOR OPTIONAL PROTECTIVE ENCLOSURE)

| Auxiliary switches | | | Control voltage | Fixed connector type | Mobile connector (without cable) | | | Sécheron's number | Connector | Overall width: XX [mm] ⁽¹⁾ |
|--|--------|------|---|----------------------|--|--------------------------|-------------|-------------------|---|---------------------------------------|
| | | | | | Number of pin (delivered with connector) | | Cable gland | | | |
| Device | Number | Type | | | Size 2.5 mm ² | Size 1.5 mm ² | | | | |
| UR10/15 with enclosure (with or without ECO-Drive) | 2a+2b | PF | 24, 32, 36, 48, 72, 87, 96, 110 V _{DC} | Harting HAN® M18 | 4 | 14 | M32 | SG102955R00001 |  | 460 ± 5 |
| | | | | | | | | SG102955R00003 |  | 431 ± 5 |
| UR10/15 with enclosure (without ECO-Drive) | 6a+6b | PF | 24, 32, 36, 48, 72, 87, 96, 110 V _{DC} | Harting HAN® M28 | 4 | 24 | M32 | SG102955R00002 |  | 460 ± 5 |
| | | | | | | | | SG102955R00004 |  | 431 ± 5 |

⁽¹⁾ Overall dimension of the enclosure with the selected mobile connector. Refer to pages 10 and 11.

INDIRECT RELEASE SELECTION

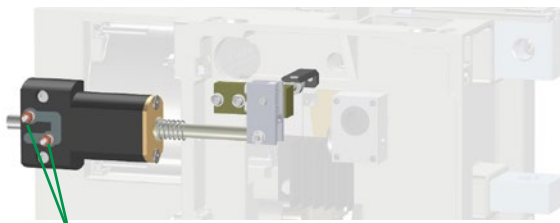

terminals

The indirect release type BIM1 enables to shorten the opening time when required by specific application.

| | | Opening time | Control Unit |
|-----------|------|--------------|----------------------|
| UR10 / 15 | BIM1 | 2-5 ms | CID-3 ⁽²⁾ |

⁽²⁾ Not included in the DC circuit-breaker - To be ordered separately. Refer to brochure SG101783

SELF SUPPORTING METAL ENCLOSURE FOR ROOF INSTALLATION

The **UR10/15** can also be installed in a self-supporting metal enclosure that can be installed on the vehicle's roof without additional supporting frame. The basic version of this metal enclosure integrates only the UR10/15 DC HSCB with or without ECO-Drive to manage the breaker's

control sequences. On a project base, this enclosure can be adapted to also integrate additional medium voltage equipment, such as voltage & current sensors, but also line & charging contactors with charging resistors.

The high voltage connection to the enclosure is achieved through high voltage bushings, while the low voltage connector in its standard configuration is of Harting HPR type.

TYPICAL EXAMPLE

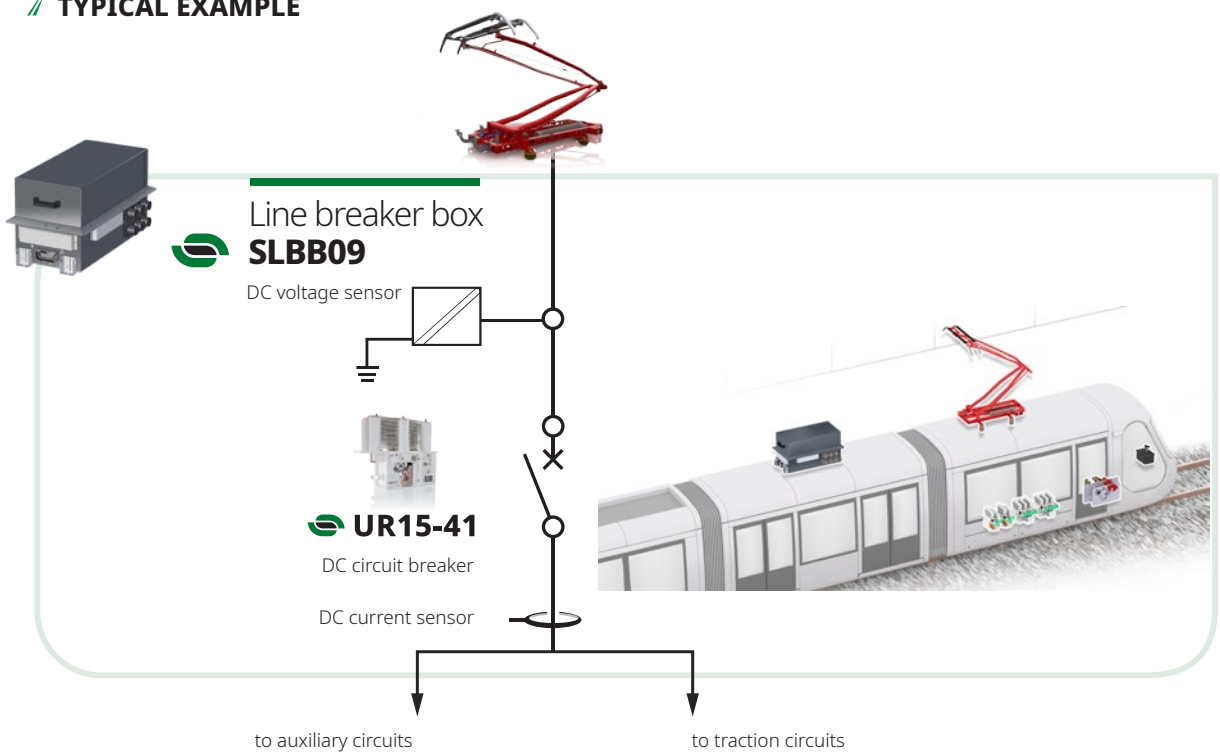

TYPICAL DIMENSION

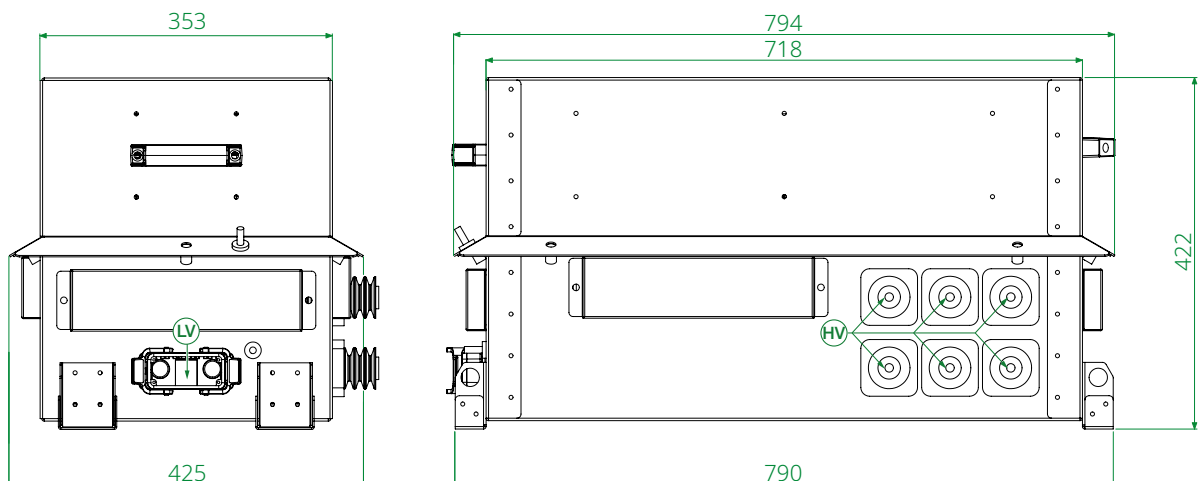

SÉCHERON COMPONENTS & SYSTEMS OVERVIEW FOR DC RAIL VEHICLES

Metro vehicles

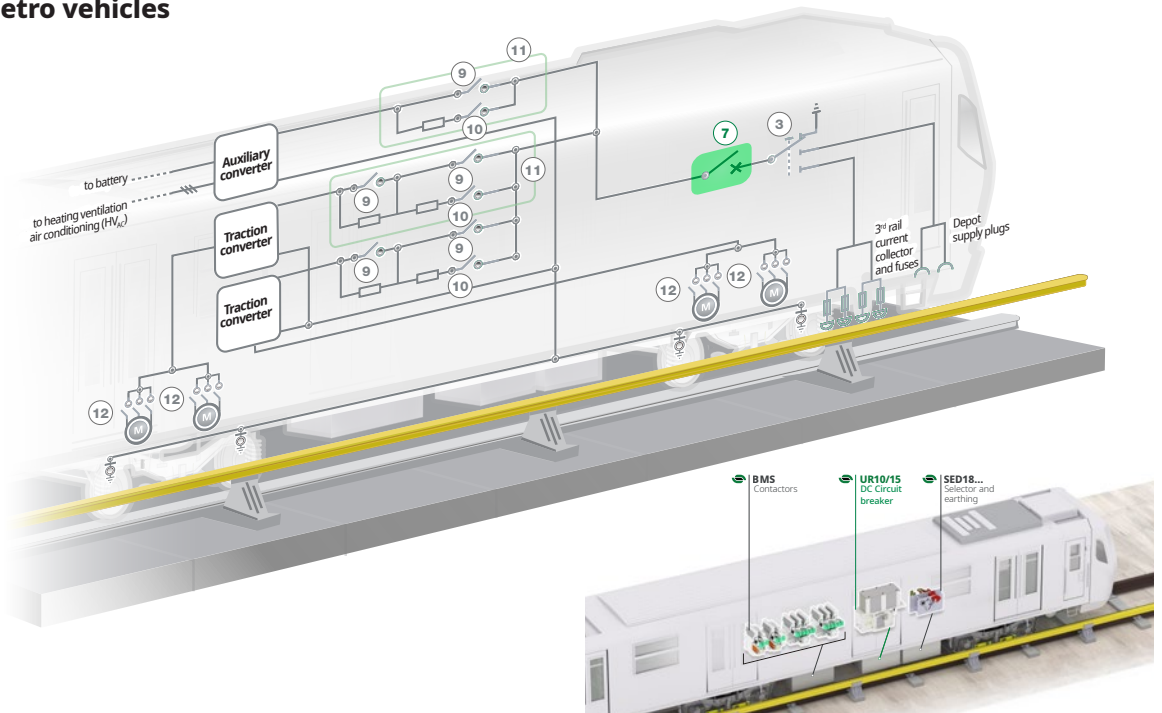

Tramway and LRV vehicles

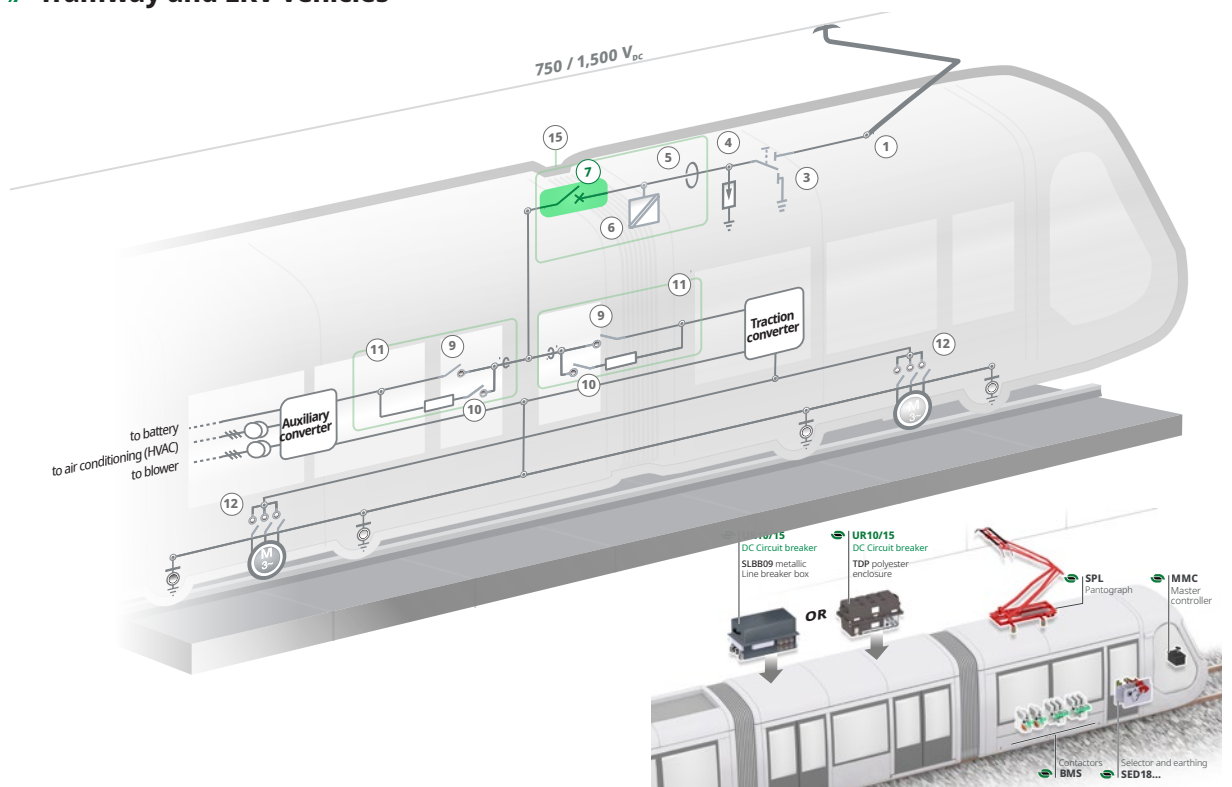

DC typical application, EMU

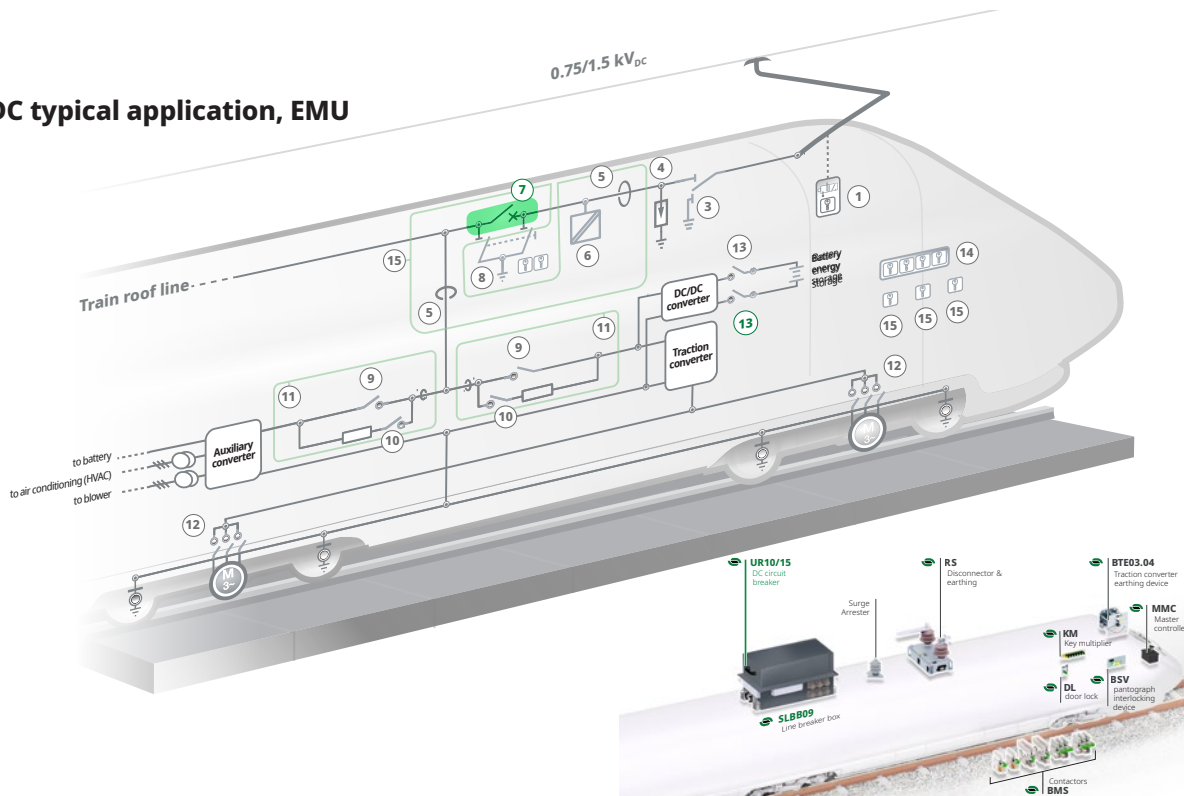

COMPONENTS FOR DC VEHICLES

REFERENCE BROCHURES

PANTOGRAPH

DC CIRCUIT BREAKER

CONTACTORS

OFF-LOAD DEVICES



SPL
SG480337BEN



UR10, UR15
SG104136BEN



BMS..08-10
SG202168BEN



BMS..08
FOR PMSM MOTOR
SA003724BEN



BSV, SLS
SP1880129BEN



SED18...
SA016456BEN



BTE03.04
SP1880136BEN



Safety Key Interlocking
SG480329BEN



KM, DL
SA011495BEN

DESIGNATION CODE FOR ORDERING

- Be sure to establish the designation code from our latest version of the brochure by downloading it from our website "www.secheron.com".
- Be careful to write down the complete alphanumeric designation code with 20 characters when placing your order.
- The customer shall write down the setting of maximum current release value (Id) in its order form.
- For technical reasons some variants and options indicated in the designation code might not be combined.
- The bold part of this designation code defines the device type, and the complete designation defines the identification number of the product, as displayed on the identification plate attached to the product.

| | | | | | | | | | | | | | | | | | |
|--------------------------------------|-----------|-----------|-----------|----------|----------|----|----|----|----|----|----|----|----|----|----|----|----|
| Example of customer's choice: | UR | 10 | 41 | T | D | - | z | z | z | z | z | A | 1 | E | C | N | 1 |
| Line: | 10 | 11 | 12 | 13 | 14 | 15 | 16 | 17 | 18 | 19 | 20 | 21 | 22 | 23 | 24 | 25 | 26 |

DESIGNATION CODE

| Line | Description | Designation | Standard | Options | Customer's choice |
|------|--|--|----------------------------|--------------------------|-------------------|
| 10 | Breaker type | UR | UR | | UR |
| 11 | Conventional thermal current ⁽¹⁾ | - 1,000 A (UR10) - 1,500 A (UR15) | 10 15 | | |
| 12 | Rated operational voltage | 900 V 1,800 V | 41 42 | | |
| 13 | Application | Traction (according to IEC 60077-3) | T | | T |
| 14 | Mounting position | Vertical | D | | |
| 15 | Protective enclosure | No For roof mounting For underframe mounting | - | P S | |
| 16 | Type of low voltage connector ⁽²⁾⁽³⁾ | (No protective enclosure) Not Applicable Harting type HAN® M | Z | 2 | |
| 17 | Type of high voltage cable gland plate ⁽²⁾ | (No protective enclosure) Not Applicable Metal - grounded | Z | M | |
| 18 | Number of glands ⁽²⁾⁽⁴⁾ | (No protective enclosure) Not Applicable - UR10 Other selection according to table page 10 - UR15 | Z | 4 6 | |
| 19 | Position of cable glands on plate ⁽²⁾⁽⁴⁾ | (No protective enclosure) Not Applicable Standard | Z | S | |
| 20 | External diameter of the HV cables ⁽²⁾⁽⁵⁾ | (No protective enclosure) Not Applicable Metric glands - UR10 26.1 - 33.0 mm (M40x1.5) - UR15 36.1 - 40.0 mm (M50x1.5) Cable glands type PG (specific execution) - UR10 26.1 - 33.0 mm (PG36) - UR15 27.0 - 35.0 mm (PG36) Other selection according to table page 10 | Z | F J Q R | |
| 21 | Nominal supply voltage | 24 V _{DC} 32 V _{DC} 36 V _{DC} 48 V _{DC} 72 V _{DC} 87 V _{DC} 96 V _{DC} ⁽⁶⁾ 110 V _{DC} 220 V _{DC} | A B C D E I | F G H | |
| 22 | Varistor on coil ⁽⁷⁾ | Yes No | 1 | N | |
| 23 | Control type | Electric holding - without ECO-Drive Magnetic holding - without ECO-Drive Electric holding - with ECO-Drive ⁽⁷⁾ | E | M 4 | |
| 24 | Range of the direct over-current instantaneous release | - UR10/15 1.2 - 2.4 kA - UR10 1.5 - 3.2 kA - UR15 1.8 - 3.6 kA Other selection according to table page 4 | C D E | | |
| 25 | Indirect release | No BIM1 | N | 1 | N |
| 26 | Auxiliary contacts | 2a + 2b - (switch PF) - silver type 6a + 6b - (switch PF) - silver type 2a + 2b - (switch PF) - Gold type 6a + 6b - (switch PF) - Gold type | 1 | 2 3 4 | |
| 27 | Colour of protective enclosure Version without protective enclosure Version with protective enclosure colour | (No protective enclosure) Not Applicable Basalt Grey (RAL 7012) | Z | 1 | |

⁽¹⁾ According to Sécheron's recommendation (refer to page 4).

⁽²⁾ Options valid with a protective enclosure.

⁽³⁾ When ordering a breaker with a protective enclosure, the low voltage mobile connector must be ordered separately according to the description page 11.

⁽⁴⁾ Refer to cable glands configuration scheme page 10.

⁽⁵⁾ The customer will have to adapt the inner diameter of the gland seals by removing the unnecessary rubber rings.

⁽⁶⁾ Only possible with holding type electric E.

⁽⁷⁾ In case control type "Electric holding - with ECO-Drive" is selected (line 23), select "No" for line 22. Option not compatible for breaker's version with protective enclosure and 6a+6b auxiliary switches.

The low voltage connector must be ordered separately:

Version with 2a+2b auxiliary contacts : SG102955R00001 Version with 6a+6b auxiliary contacts : SG102955R00002

Other type: SG.....

Value of the setting of the direct over-current release A_0 (I_{ds}) :[A]



Sécheron SA
Rue du Pré-Bouvier 25
1242 Satigny - Geneva
CH-Switzerland

www.secheron.com
Tel: +41 22 739 41 11
Fax: +41 22 739 48 11
ess@secheron.com



SG104136BEN_C06-03.23

Signature:

Name:

Place and date: